



DKG-255

DIGITAL SPEED CONTROLLER

DESCRIPTION

The DKG-255 is a microprocessor controlled digital speed control unit with fast and accurate response to load changes.

The DKG-255 connects to a forward acting proportional electric actuator and a magnetic speed sensor. It has a different version capable of picking-up the speed signal from the alternator voltage, removing the need for a MPU unit.

The unit controls a wide variety of engines in constant speed (isochronous) or droop modes.

The DKG-255 offers programmable parameters to adjust IDLE and RATED speed settings. The IDLE speed mode is selected with an external switch.

The automatic PID speed regulation function controls the dynamic performance of the unit and allows stable operation with most engine types.

The unit is able to adjust automatically its PID settings, simplifying the programming process and improving the dynamic response quality.

An external speed trim potentiometer may be connected to the unit to adjust the engine speed from a remote location.

The auxiliary speed adjustment input allows voltage controlled speed trimming for synchronizing and load sharing applications.

If an adequate speed signal is not supplied to the unit, the speed signal monitoring circuit will detect this and shut-off the actuator output in order to prevent any damage.

The unit is capable to deliver actuator currents as high as 10 Amps. However, the output current limiting circuit will protect the unit against output short circuit or overload.

Protection against reverse battery connection and transient voltages are provided.

FEATURES

- **Automatic PID Setup functionality**
- **Microprocessor controlled**
- **12 and 24V operation**
- **Capable of governing various engines**
- **Forward acting actuator output**
- **Fast and accurate response**
- **Starting fuel adjustment**
- **Speed ramp adjustment**
- **Adjustable rated and idle speeds**
- **Isochronous and droop operation**
- **Gain and stability adjustments**
- **External speed adjustment capability**
- **Synchronizing and load sharing input**
- **Switch mode output circuit**
- **10 Amps continuous current output**
- **Speed sensor failure detection**
- **Battery reverse voltage protection**
- **Output short circuit protection**
- **Rugged design**
- **Enamel protected electronic circuit**
- **Small dimensions (130x110x27mm)**
- **Low cost**

COPYRIGHT NOTICE

Any unauthorized use or copying of the contents or any part of this document is prohibited. This applies in particular to trademarks, model denominations, part numbers and drawings.

ABOUT THIS DOCUMENT

This document describes minimum requirements and necessary steps for the successful installation of the DKG-255 unit.

Follow carefully advices given in the document. These are often good practices for the installation of digital speed control unit which reduce future issues.

For all technical queries please contact Datakom at below e-mail address:

technical.support@datakom.com.tr

QUERRIES

If additional information to this manual is required, please contact the manufacturer directly at below e-mail address:

technical.support@datakom.com.tr

Please provide following information in order to get answers to any question:

- Device model name (see the back panel of the unit),
- Complete serial number (see the back panel of the unit),
- Firmware version (read from the display screen),
- Measuring-circuit voltage and power supply voltage,
- Precise description of the query.

REVISION HISTORY

REVISION	DATE	AUTHOR	DESCRIPTION
01	10.04.2019	MH	First edition, firmware version 1.0

TERMINOLOGY



CAUTION: Potential risk of injury or death.



WARNING: Potential risk of malfunction or material damage.



ATTENTION: Useful hints for the understanding of device operation.

**SAFETY NOTICE**

**Failure to follow below instructions
will result in death or serious injury**



- Electrical equipment should be installed only by qualified specialist. No responsibility is assured by the manufacturer or any of its subsidiaries for any consequences resulting from the non-compliance to these instructions.



- Check the unit for cracks and damages due to transportation. Do not install damaged equipment.



- Do not open the unit. There are no serviceable parts inside.



- A fuse must be connected to the power supply input, in close proximity of the unit.



- Fuses must be of fast type with a maximum rating of 16A.



- Disconnect all power before working on equipment.



- When the unit is connected to the network do not touch terminals.



- Any electrical parameter applied to the device must be in the range specified in the user manual. Although the unit is designed with a wide safety margin, over-range parameters may reduce lifetime, alter operational precision or even damage the unit.



- Do not try to clean the device with solvent or the like. Only clean with a damp cloth.



- Verify correct terminal connections before applying power.

TABLE OF CONTENTS

- 1. INSTALLATION INSTRUCTIONS**
 - 1.1 INTRODUCTION TO THE CONTROL UNIT
 - 1.2 MOUNTING THE UNIT
 - 1.3 WIRING THE UNIT
- 2. TERMINAL DESCRIPTIONS**
- 3. TECHNICAL SPECIFICATIONS**
- 4. DESCRIPTION OF CONTROLS**
 - 4.1. FRONT PANEL FUNCTIONALITY
 - 4.2. PUSHBUTTON FUNCTIONS
 - 4.3. LED DISPLAY ORGANIZATION
- 5. PROTECTION AND ALARMS**
- 6. PROGRAMMING**
- 7. PROGRAM PARAMETER LIST**
- 8. OPERATION OF THE UNIT**
 - 8.1. AUTO PID SETUP
- 9. OTHER FEATURES**
 - 9.1. ISOCHRONOUS AND DROOP OPERATION
 - 9.2. IDLE SPEED SELECTION
 - 9.3. EXTERNAL SPEED ADJUSTMENT
 - 9.4. SPEED ADJUSTMENT FOR AUTOMATIC SYNCHRONIZATION
 - 9.5. STARTING FUEL ADJUSTMENT
 - 9.6. SPEED RAMPING ADJUSTMENT
 - 9.7. OVERSPEED ALARM ADJUSTMENT
 - 9.8. SAVING AND RESTORING THE CONFIGURATION
 - 9.9. FIRMWARE UPDATE
- 10. CONNECTION DIAGRAM**
- 11. DECLARATION OF CONFORMITY**
- 12. MAINTENANCE**
- 13. DISPOSAL OF THE UNIT**
- 14. ROHS COMPLIANCE**
- 15. TROUBLESHOOTING GUIDE**

1. INSTALLATION INSTRUCTIONS

1.1 Introduction to the Control Unit

The DKG-255 is a microprocessor controlled governor control unit designed to control the engine speed with fast and accurate response to load changes.

The DKG-255 connects to a **forward acting** proportional electric actuator and a magnetic speed sensor. It is able to control a wide variety of engines in constant speed (isochronous) or droop modes.

Thanks to its PID control system, the optimal response specific to each engine is performed.

The unit is capable of delivering actuator currents as high as 10 Amps. However, the output circuit is protected against short circuit and overload.

Protection against reverse battery connection and transient voltages are provided.

The unit is suitable for both 12 and 24V operation.

1.2 Mounting the Unit

The unit is designed to be mounted inside a control cabinet. A vertical mounting position is preferred so that the heat is dissipated with vertical airflow.

Extreme heat may affect the performance of the unit and should be avoided.

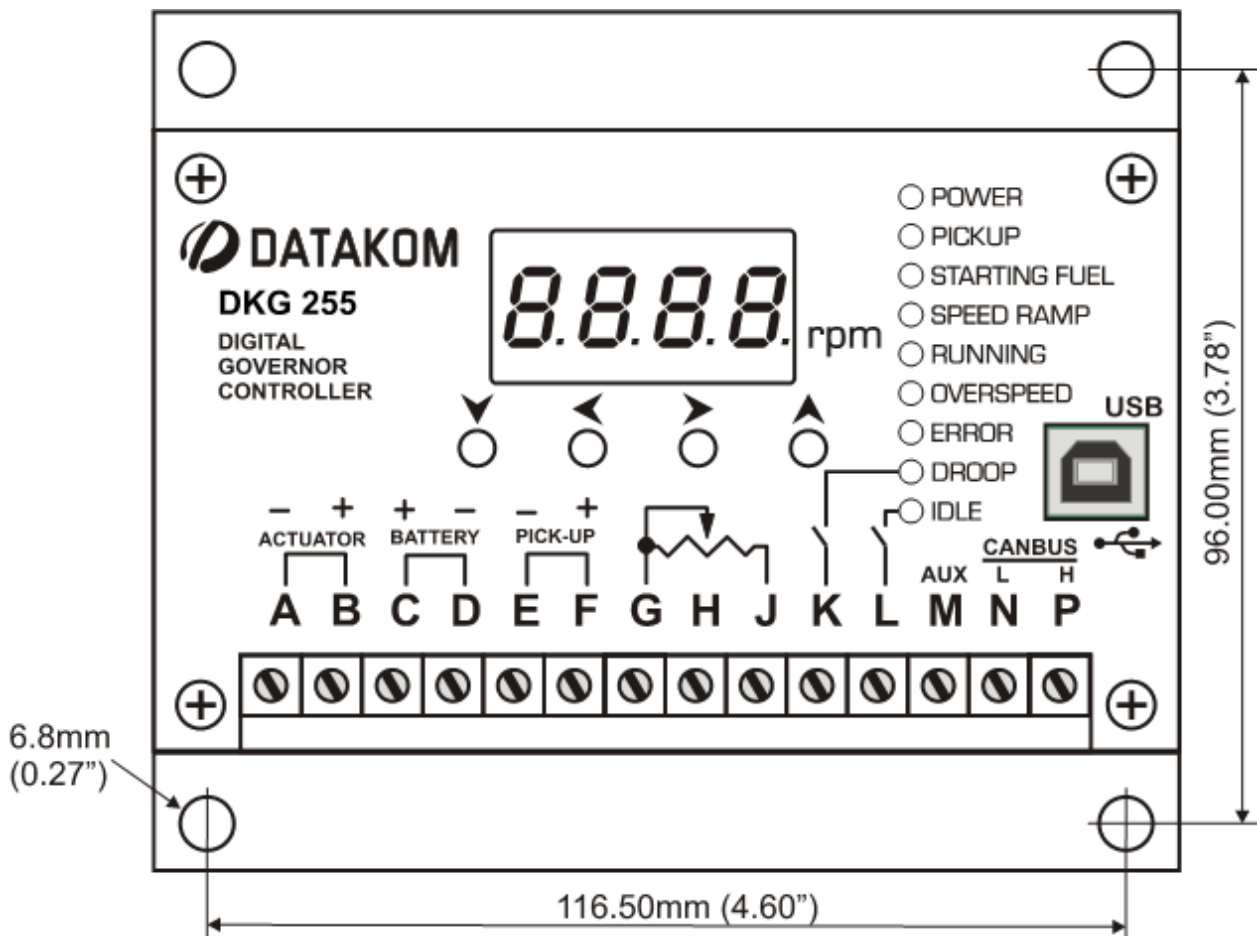

1.3 Wiring the Unit

Cables of section 1.5mm² or higher should be used for battery and actuator connections (terminals A-B-C-D). The section needs to be increased with long cable lengths.



THE UNIT IS NOT FUSED. Use external fuse for battery positive (terminal C) Install the fuse as nearly as possible to the unit.

The fuse rating should be 16 Amps.

The signal connections on terminals E-F-G-H-J should be twisted or shielded for the entire length of the cable. The shield should be grounded at one end only. The other end of the shield should be left unconnected in order to avoid current flowing through it.

The gap between the magnetic speed sensor and the ring gear teeth should not be less than 0.50mm (0.020"). The usual way of adjusting the gap is backing up the sensor 3/4 turn after touching the ring gear teeth.

The magnetic speed sensor voltage should be at least 1.5 VAC RMS during cranking.



Do not rely exclusively on the governor controller-actuator system for engine overspeed protection. An additional overspeed shutdown means controlling the fuel solenoid should be installed on the engine.

2. TERMINAL DESCRIPTIONS

Term	Function	Technical data	Description
A	Actuator -	Output, 10A max	These outputs supply energy to the electric actuator. The output voltage will increase in order to supply more fuel to the engine. An overload/short circuit protection is provided.
B	Actuator +		
C	Battery +	Input, 12/24VDC	Power supply connection. Use cables of adequate section for the actuator.
D	Battery -		
E	Magnetic pick-up -	Input, 1.5 - 300VAC	Connect the magnetic pickup terminals to these inputs. The input voltage cannot be less than 1.5VAC. A signal of at least 3 VAC-RMS is recommended. The cable should be either twisted or shielded.
F	Magnetic pick-up +		
G	Speed Trim	Input	Connect an external speed trim potentiometer to adjust the engine speed.
H			
J			
K	Droop	Input	Connecting this terminal to battery negative will cause DROOP operation. The DROOP range is adjusted through DROOP program parameter.
L	Idle	Input	Connecting this terminal to battery negative will switch to IDLE SPEED operation. The IDLE SPEED is adjusted with the IDLE programmable parameter.
M	External speed adjust	Input, 0-10VDC	The external speed adjustment voltage should be connected to this input. The cable should be either twisted or shielded.
N	CAN L		This feature will be available soon.
P	CAN H		

3. TECHNICAL SPECIFICATIONS

DC Supply Range: 10.0 to 33.0 V-DC

Current consumption: 100mA max (actuator not connected)

Speed input range: 40 Hz to 8000 Hz.

Speed signal amplitude: 1.5 to 300 VAC-RMS

Speed signal input impedance: 2 M- ohms

External speed trim:

5 K-ohms trimpot between terminals G and J

External speed trim range: $\pm 6\%$ min @3000Hz

Auxiliary input (terminal M):

Input voltage range: 0 to 10VDC

Input impedance: 150 k-ohms.

Adjustment range: $\pm 25\%$ min @3000 Hz

Steady state speed accuracy: $\pm 0.2\%$

Droop adjustment range: 1 to 5% minimum

Actuator output: 10 Amps continuous max

Operating temp.: -20°C (-4°F) to 70°C (158°F).

Storage temp.: -30°C (-22°F) to 80°C (176°F).

Maximum humidity: 95% non-condensing.

Dimensions: 130 x 110 x 27 mm (WxHxD)

Weight: 350 g (approx.)

Mounting: any position, vertical preferred





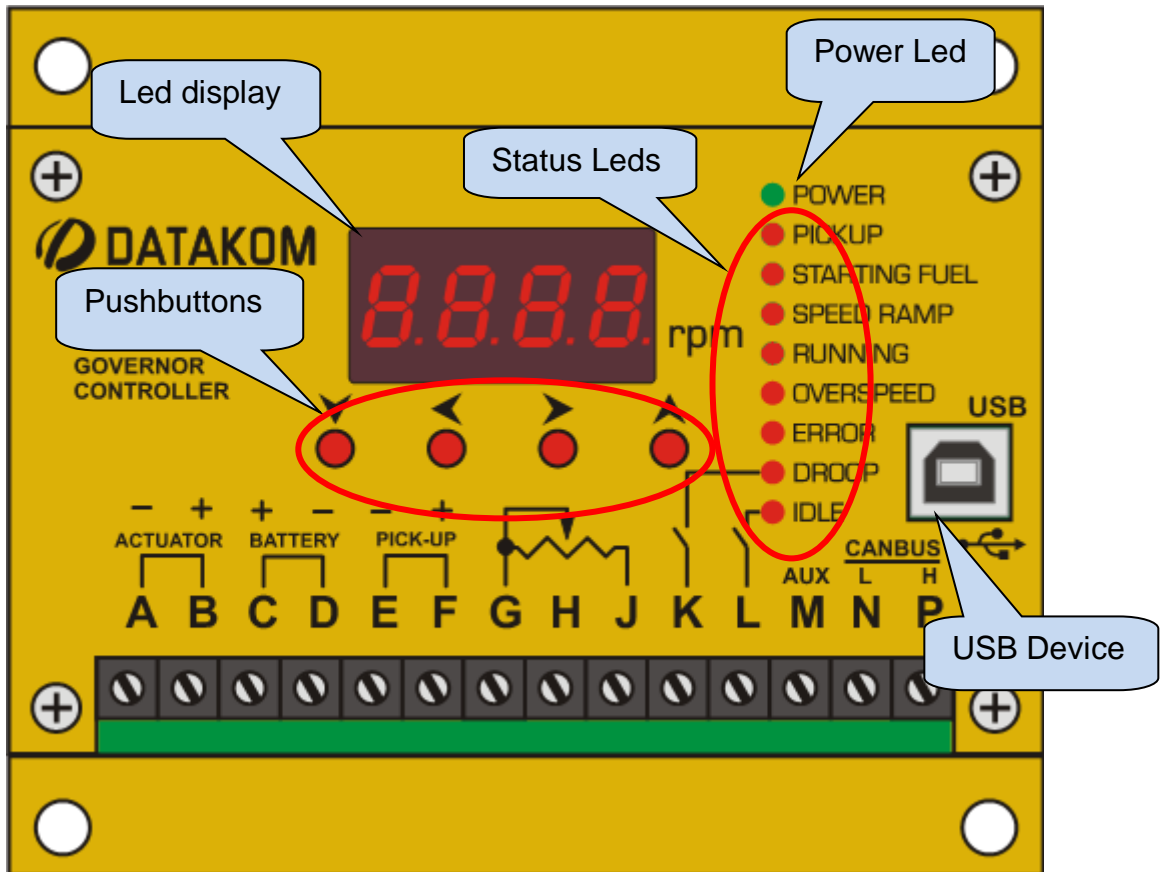

4. DESCRIPTION OF CONTROLS

4.1. FRONT PANEL FUNCTIONALITY



LED	COLOR	FUNCTION
Power	green	Led turns on when battery voltage is supplied to terminals C-D.
Pickup	red	Led turns on when speed signal is available at terminals E-F
Starting Fuel	red	Led turns on when the engine rpm is above “ cranking rpm ” value and the actuator output is active as defined by “ starting fuel ” parameter.
Speed Ramp	red	Led turns on when the rpm reaches “ running rpm ” value and the speed is increasing as defined by “ speed ramp ratio ” parameter.
Running	red	Led turns on when the engine reaches its nominal speed.
Overspeed	red	Led turns on when engine speed is above the overspeed limit.
Error	red	Led turns on when an error condition occurs.
Droop	red	Led turns on when the droop input is active. (terminal_K)
Idle	red	Led turns on when the idle input is active. (terminal_L)

4.2. PUSHBUTTON FUNCTIONS

BUTTON	FUNCTION
	Switches the display to the parameter name of the value displayed on led screen. PROGRAMMING MODE: Save the set value and select next parameter.
	PROGRAMMING MODE: Return to main menu of parameters.
	Switches the display to the next measured parameter. Switches to alarm menu to display error codes. PROGRAMMING MODE: <ul style="list-style-type: none"> • Select next parameter. • Increase the value of selected parameter.
	Switches the display to the previous measured parameter. PROGRAMMING MODE: <ul style="list-style-type: none"> • Select previous parameter. • Decrease the value of selected parameter.
	When held pressed for 5 seconds, enters PROGRAMMING mode.
	When held pressed for 5 seconds, resets alarms.

4.3. LED DISPLAY ORGANIZATION



The unit is a control and protection device used in diesel engines. It shows measured values on its display. The unit is designed to provide user friendliness for both the installer and the user.

The measured parameters are:

- Engine RPM
- Frequency
- Battery Voltage
- Minimum rpm
- Maximum rpm

The unit has a 4 digit seven segment display that shows:

- Measurements
- Program parameters
- Firmware version

The navigation between measurement screens is made with  button. By pressing the  button, the name of the measured value will be displayed.

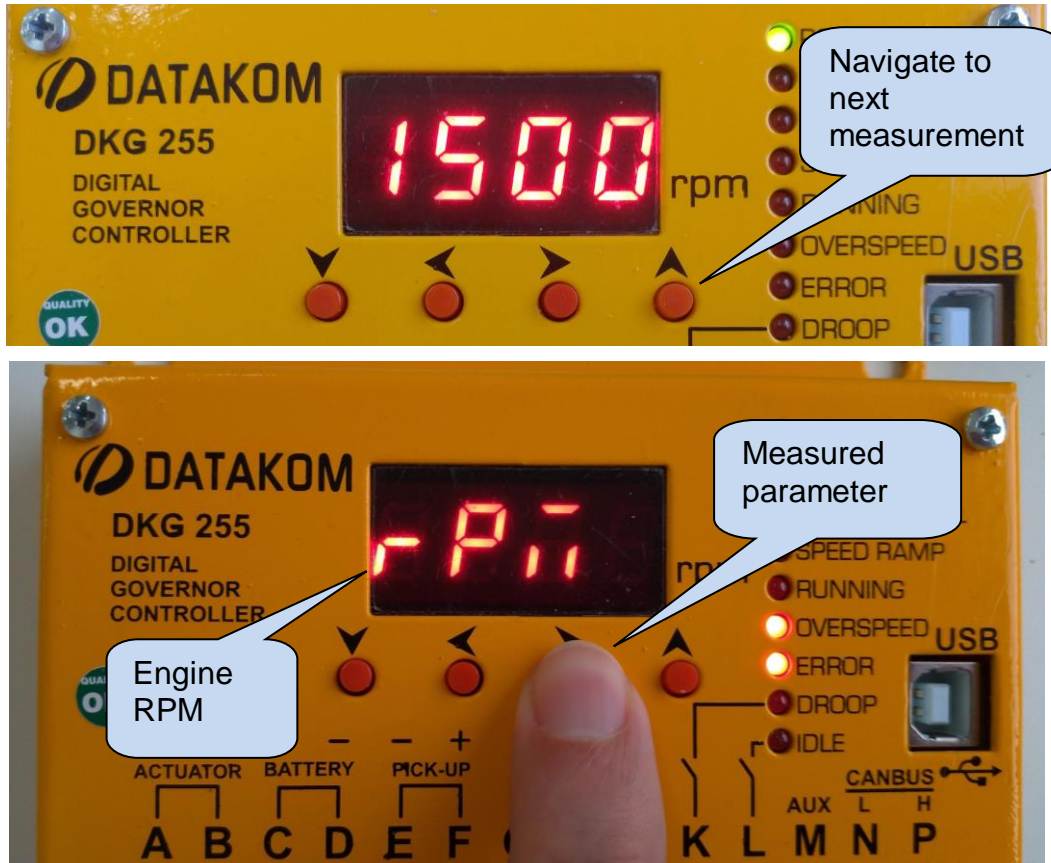

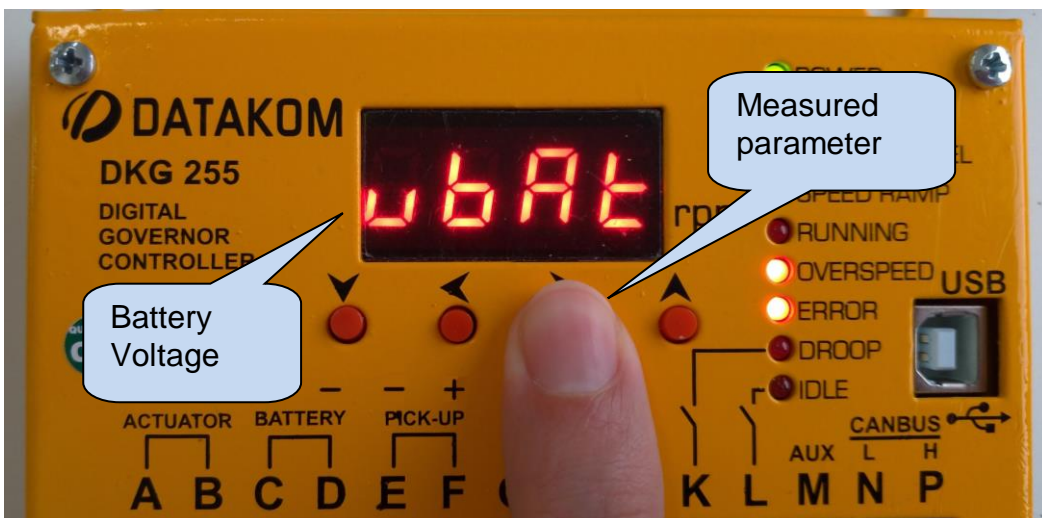
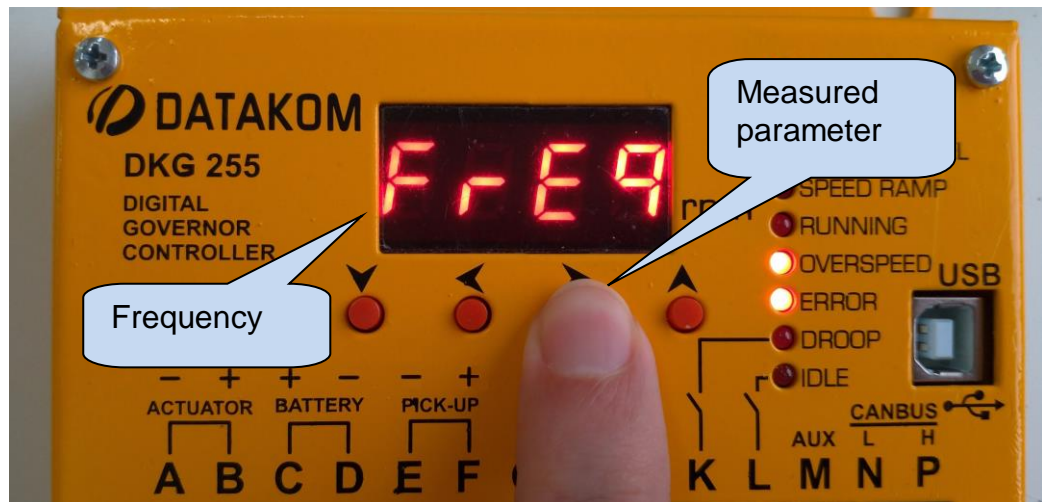
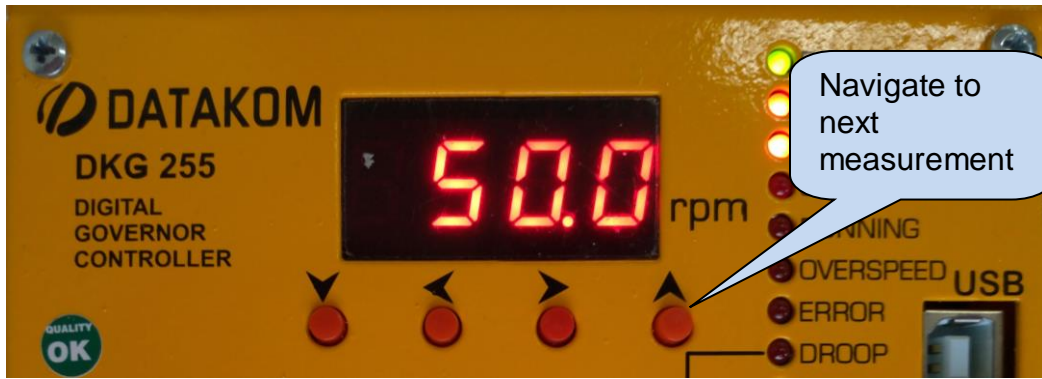

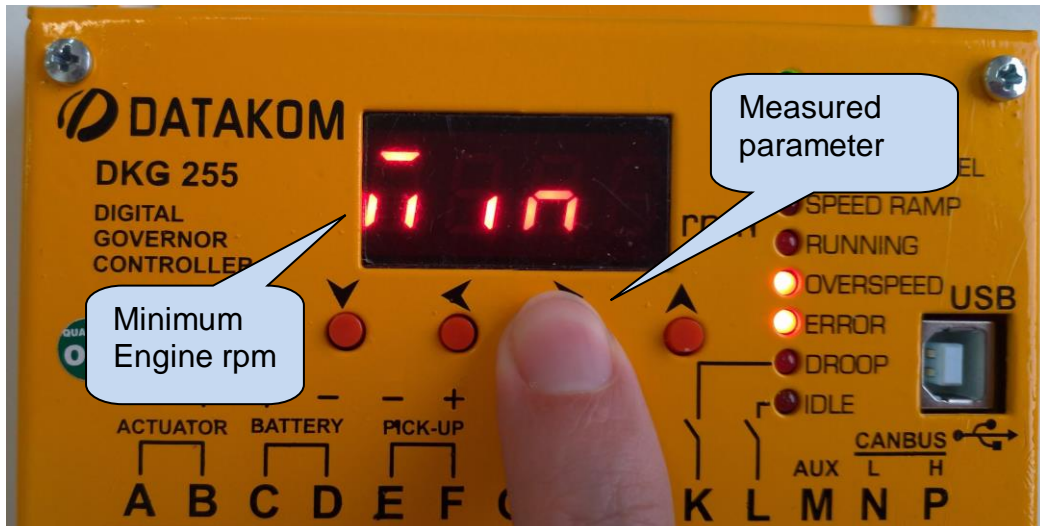

5. PROTECTIONS AND ALARMS

The unit continuously monitors abnormal conditions during operation. Programmable alarm limits are provided for every measured value.

If any fault condition occurs, the related error led turns on and an alarm code is displayed.

ALARM CODE	DESCRIPTION
Err1	High Battery Voltage. This alarm occurs if battery voltage is higher than 30VDC.
Err2	Low Battery Voltage. This alarm occurs if battery voltage is below set value.
Err3	MPU Error. This alarm occurs if mpu signal is lost when engine speed is below 600rpm.
Err4	MPU Error. This alarm occurs if mpu signal is lost when engine speed is above 600rpm.
Err5	Shot circuit or overload at actuator output.
Err6	Overspeed.

Press Up button to view error codes.

Hold pressed Up and Down buttons together for 5 seconds to reset errors.

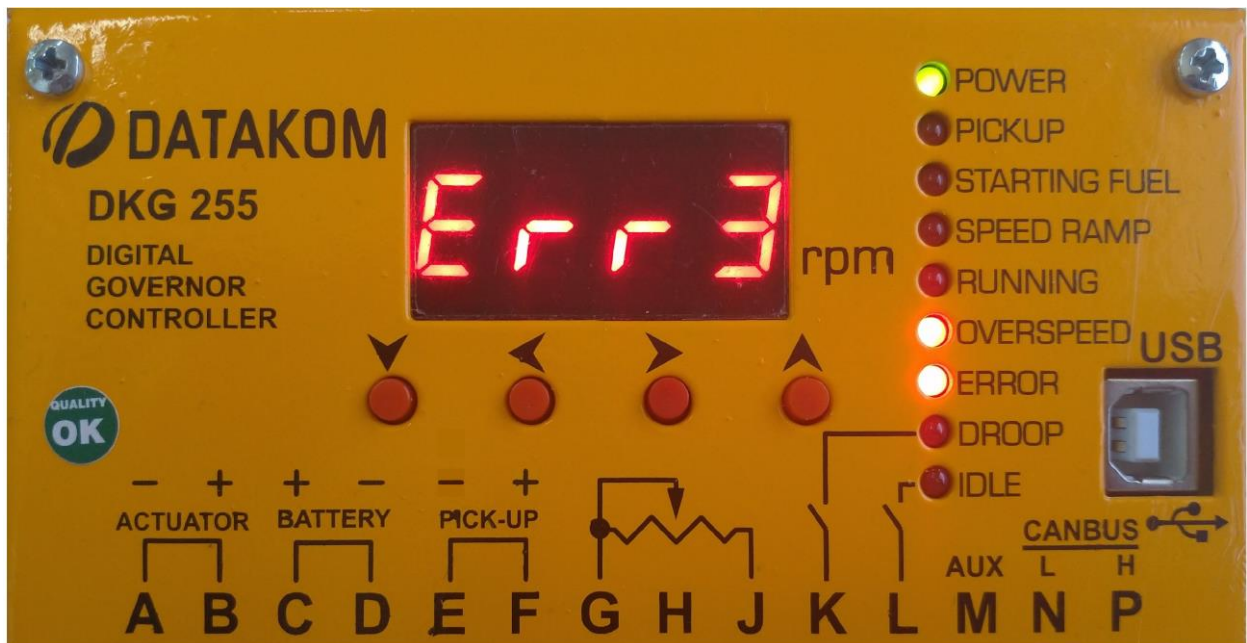

6. PROGRAMMING

The program mode is used to adjust parameters. To enter the program mode, hold pressed ◀ ▶ buttons for 5 seconds.

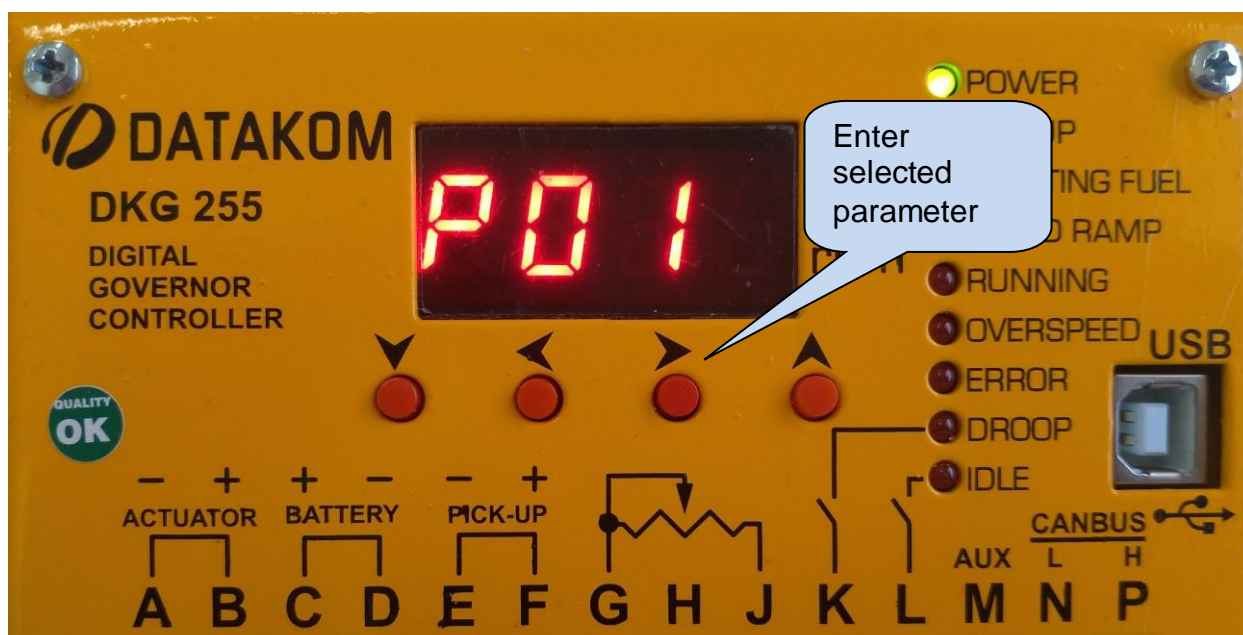
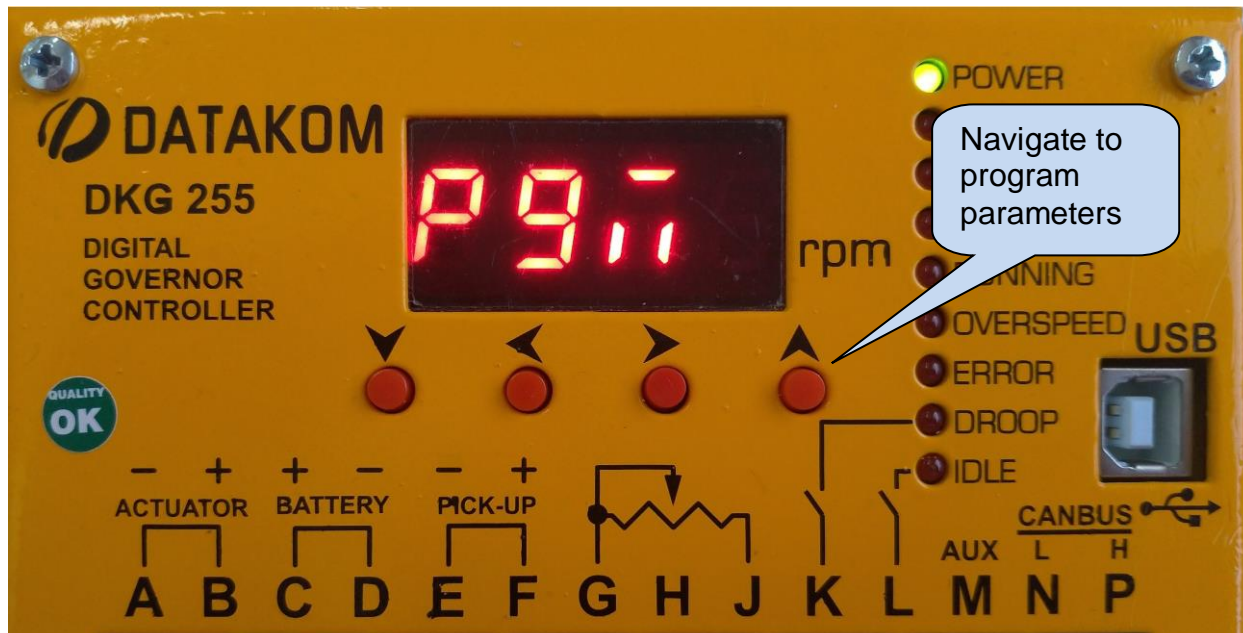

When the program mode is entered, the display will show “PGM”.

The program mode will not affect the operation of the unit. Thus, programs may be modified anytime, even while the engine is running.



Navigation between program parameters is performed via the  button.

Press  button to enter inside the selected parameter.

Parameter value may be increased and decreased with  and  buttons.

When a program parameter is modified, press  button to save in memory.

If  button is pressed, it returns to main menu of programming without saving the value.

Program parameters are kept in a non-volatile memory and are not affected from power failures.

To exit the program mode, hold pressed  buttons together.

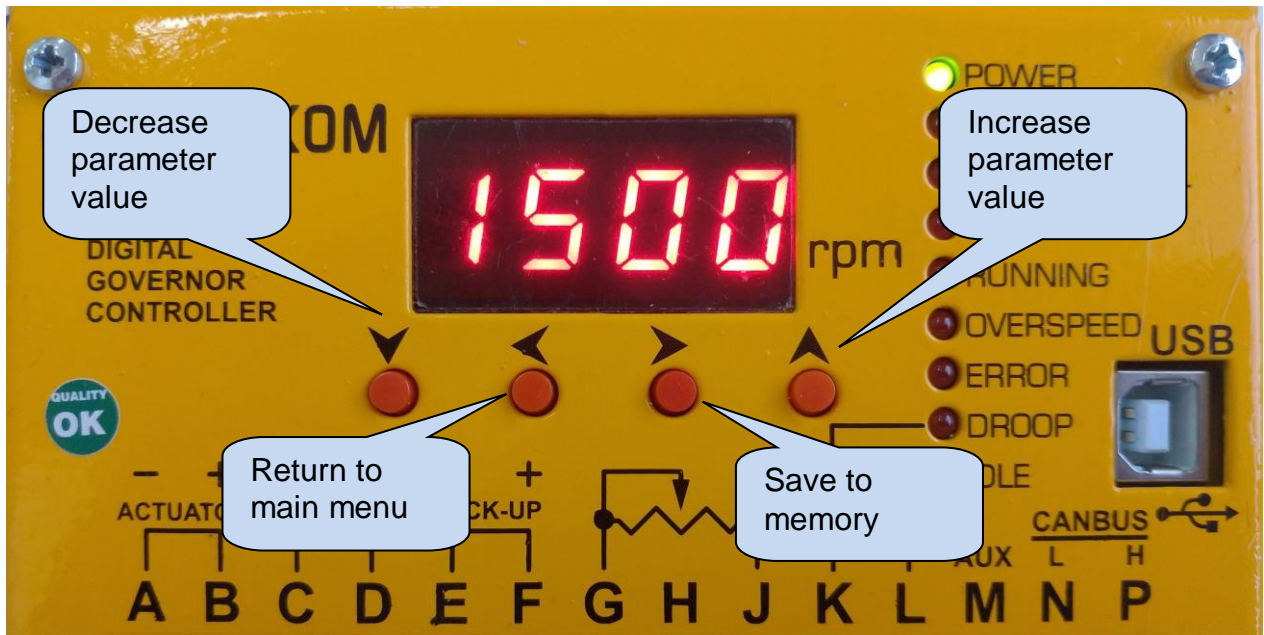

7. PROGRAM PARAMETER LIST

Parameter Definition	Unit	Min	Max	Factory Set	Description
P_01 Nominal Speed	rpm	1000	2000	1500	This parameter defines the nominal (target) speed of the engine.
P_02 Idle Speed	rpm	500	1500	900	This parameter defines the idle speed of the engine when idle input is active.
P_03 Delayed Overspeed Limit	%	105	200	110	If the engine rpm goes over this limit during overspeed delay timer (P_05), this will generate an overspeed alarm.
P_04 Immediate Overspeed Limit	%	110	200	120	If the engine rpm goes over this limit, this will generate an overspeed alarm.
P_05 Overspeed Delay Timer	sec	1	10	5	If the engine rpm goes over P_03 during this timer, this will generate an overspeed alarm.
P_06 Cranking rpm	rpm	0	300	10	During engine cranking, if the rpm is above this limit, the unit activates the actuator output. (P_09)
P_07 Running rpm	rpm	300	1000	400	This parameter is the limit to start speed ramping with PID control.
P_08 Crank Teeth Count	-	2	500	100	This parameter defines the flywheel teeth number of engine.
P_09 Starting RPM Fuel	%	5	100	45	This parameter defines the amount of actuator output during cranking.
P_10 Running RPM Fuel	%	0	100	50	This parameter defines the amount of actuator output when the engine has fired. It is calculated as a percentage of parameter P_09.
P_11 Speed Ramping rpm	Rpm / sec	10	9999	200	This parameter defines the value of the speed ramping in rpm/sec.
P_12 Low Battery Voltage	Vdc	2	30	8	This parameter defines the low battery voltage alarm limit.
P_13 Global Gain	-	1	9000	20	This parameter governs the nominal rpm catching of the controller. If this parameter is increased, the operation will be faster but unstable. If it is decreased, the operation will be slower but more stable. The optimal setting is the fastest stable operation.
P_14 P Gain	-	0	9999	100	Proportional gain.
P_15 I Gain	-	0	9999	50	Integral gain.
P_16 D Gain	-	0	9999	40	Derivative gain.
P_17 Aux Enable	-	0	1	0	0: Aux input disabled 1: Aux input enabled
P_18 Aux Speed	rpm	10	300	300	This parameter defines the value of speed change when aux is enabled.
P_19 Droop Gain	% / A	0.1	10	4	This is the parameter to adjust the amount of droop.
P_20 Trim Enable	-	0	1	0	This is the parameter to enable speed control with external potentiometer. 0: External speed trim disabled 1: External speed trim enabled
P_21 Trim Gain	%	5	20	10	This is the percentage of running rpm to adjust the engine speed with external potentiometer.

7. PROGRAM PARAMETER LIST (continued)

Parameter Definition	Unit	Min	Max	Factory Set	Description
P_22 PID Auto Setup	-	0	1	0	This is the parameter to enable auto PID setup operation. 0: PID Auto Setup disabled 1: PID Auto Setup enabled
P_23 Actuator Maximum Value	%	30	100	100	This parameter defines the maximum value of actuator output.
P_24 Actuator Minimum Value	%	0	50	0	This parameter defines the minimum value of actuator output.
P_25 Save Configuration	-	0	15	0	This parameter is used to save current configuration of the device. User defined configurations can be saved with the numbers from 2 to 15. 1 is default factory settings of the device.
P_26 Restore Configuration	-	0	15	0	This parameter is used to restore user defined configurations of the device. 1 is the default factory settings of the device. User defined configurations can be restored from 2 to 15.
P_27 Rpm Read from Canbus	-	0	1	0	This is the parameter to enable rpm target setting through canbus communication. This feature will be available soon. 0: Canbus rpm read is disabled 1: Canbus rpm read is enabled
P_28 Boot Mode Enable	-	0	1	0	This is the parameter to enable firmware update mode. In order to cancel boot mode, turn power off and on again. 0: Boot mode disabled 1: Boot mode enabled

8. OPERATION OF THE UNIT

The unit is designed to operate from a DC supply of 12 or 24 volts, which is usually the engine starter battery. The battery is connected to terminals C and D. A reverse polarity protection is provided.

The unit should be supplied with a speed signal at the inputs E and F. The signal comes usually from a magnetic pickup unit mounted in close proximity of the engine ring gear. The frequency of the speed signal is proportional to the engine rpm.

The minimum acceptable amplitude of the speed signal is **1.5 VAC-RMS**. The acceptable frequency range is 40 Hz to 8'000 Hz. If MPU unit is connected, the use of a shielded cable is recommended. The shield should be grounded at one end only.

The actuator output is energized only when a speed signal is present. The unit will shut-off the actuator if an adequate signal is not connected to the inputs.

The engine speed is adjusted from **P_01 Nominal Speed** parameter. This will allow a precise adjustment of the desired engine rpm.

The stability of the speed is adjusted with the **P_13 Global Gain** parameter. This parameter will modify the dynamic response of the unit to speed changes and allow adaptation to different type of engines.

The GAIN parameter adjusts the reaction rate of the unit to speed changes. The unit will become more sensitive as the parameter is increased. This will allow a faster return to the nominal speed when a load change occurs. Do not forget that excess gain will cause instability.

The **STARTING RPM FUEL P_09**, **RUNNING RPM FUEL P_10** and **SPEED RAMP P_11** parameters will prevent the actuator from opening completely and minimize engine exhaust smoke.

The **OVERSPEED** parameters adjusts the speed alarm threshold. When the engine overspeeds, this will activate the overspeed alarm and the related error led will turn on.

During cranking, the speed signal will be below the **P_07 Running rpm**, which causes the actuator to open as defined by **P_09 Starting RPM Fuel**. When the engine has fired and the speed reaches **P_07 Running rpm**, the unit will initiate speed ramping until the engine reaches the nominal speed. Then the actuator will be supplied only with the amount of current necessary to maintain the nominal speed.

A sudden load increase on the engine shaft will result to a speed drop. This will cause the actuator to open more in order to reach the nominal speed. A sudden load decrease will cause a speed increase. This will cause the actuator to shut-off gradually until reaching again the nominal speed.



The actuator output is a switchmode circuit which supplies nearly the battery voltage when turned on. This allows the unit to deliver high output currents with high efficiency and minimum self-heating. The switching frequency is well above the natural oscillation frequency of the actuator moving parts and is not detectable.

8.1. AUTO PID SETUP

The unit offers the automatic learning feature for adjusting PID coefficients.

In order to activate the auto PID setup:

After starting the engine, enter programming parameters and select **P_22 Auto PID Setup** parameter.

Press  button to set 1 and then press  button to confirm. The unit will start to modify the engine speed in order to calculate optimum PID coefficients. If operation is completed successfully, OK message will be written on display. An error message will be displayed if auto PID setup fails.



Auto PID setup operation must be performed with no load.

9. OTHER FEATURES

9.1. Isochronous and Droop Operation

The typical operation mode of the unit is isochronous (constant speed). However, a droop operation may be required for load sharing purposes on genset engines.

In droop operation, the engine speed will decrease slightly with load increase. The load information is picked up from the actuator current, which increases together with the load.

The droop operation is selected by connecting the terminal **K** to battery negative. The amount of droop is adjusted by **P_19 Droop Gain** parameter.

The droop range will be different for each engine-actuator combination. For a current increase of 1 Amperes, the droop range is adjustable within 1 to 5 % of the nominal speed.

As the actuator current is not zero at no-load condition, this will cause a droop even if the engine runs without load. Thus the droop adjustment modifies the nominal speed setting.



It is necessary to readjust the no-load speed after droop adjustment.

9.2. Idle Speed Selection

The unit offers the possibility of Idle/Nominal speed switching using an external switch. The idle speed is independently adjustable from **P_02 Idle Speed** parameter.

The idle speed is selected by connecting the terminal **L** to battery negative.

Switching between idle and nominal speeds can be done while the engine is running.

9.3. External Speed Adjustment

An external speed adjustment potentiometer can be connected between terminals **G**, **H** and **J**. The potentiometer value should decrease with a clockwise rotation (speed increase).

The recommended potentiometer value is 5 K-ohms. A different value may also be used for an exact match of the desired adjustment range.

The external adjustment cable should be shielded for the best operation. The cable should be shielded at one end only.

Speed control with external potentiometer must be enabled from **P_20 Trim Enable** parameter.

9.4. Speed Adjustment for Automatic Synchronization

External speed adjustment signal from other control devices may be applied between terminal **M** and battery negative.

The input accepts 0 to 10V DC signals.

The remote speed adjustment cable should be shielded for the best operation. The cable should be shielded at one end only.

This feature must be enabled from **P_17 Aux Enable** parameter.

9.5. Starting RPM Fuel Adjustment

P_09 STARTING RPM FUEL parameter adjusts the fuel amount during engine cranking.

A high starting fuel adjustment helps the engine to fire faster.

However the minimum necessary amount of starting fuel should be used in order to minimize engine exhaust smoke during cranking.

9.6. Speed Ramping Adjustment



The Speed Ramp adjusts the time that the engine requires to reach the nominal speed from idle speed.

The engine will ramp faster to the nominal speed with increased values of **P_11**.

9.7. Overspeed Alarm Adjustment

If the engine rpm goes over **P_03 Delayed Overspeed Limit** during **P_05 Overspeed Delay Timer**, this will generate overspeed alarm. Overspeed alarm is set immediately if the engine rpm is above **P_04 Immediate Overspeed Limit**.

When an overspeed alarm occurs, **OVERSPEED** and **ERROR** leds will turn on and “err6” message is displayed on the screen.

Hold pressed  and  buttons together to reset overspeed alarm.

9.8. Saving and Restoring the Configuration

P_25 Save Configuration parameter allows user to save the current configuration of the device.

The device offers 14 different memory locations to save the configuration. Thus different configurations can be saved to different memory locations and any of them can be restored later.

The memory location 1 is reserved for the factory set configuration. It cannot be overwritten, but may be restored anytime.

If the user selects the memory location number from **P_26 Restore Configuration** parameter, parameters will be automatically configured accordingly.

In order to return to factory settings, **P_26** must be set to 1.

9.9. Firmware Update

Firmware update can be done if the manufacturer releases an update about the operation of device.

The firmware file cannot be read from the unit and it is always required to get the original firmware file from the manufacturer.

To force the device to firmware update mode, **P_28 Boot Mode** parameter must be set to 1.

The unit in **BOOT LOADER** mode will wait for a PC connection through its USB port. When the unit establishes USB connection, the device will be automatically recognized by the PC and will appear as a Device with Removable Storage. After deleting firmware file, copy the new firmware provided by Datakom into this disk.

10. CONNECTION DIAGRAM

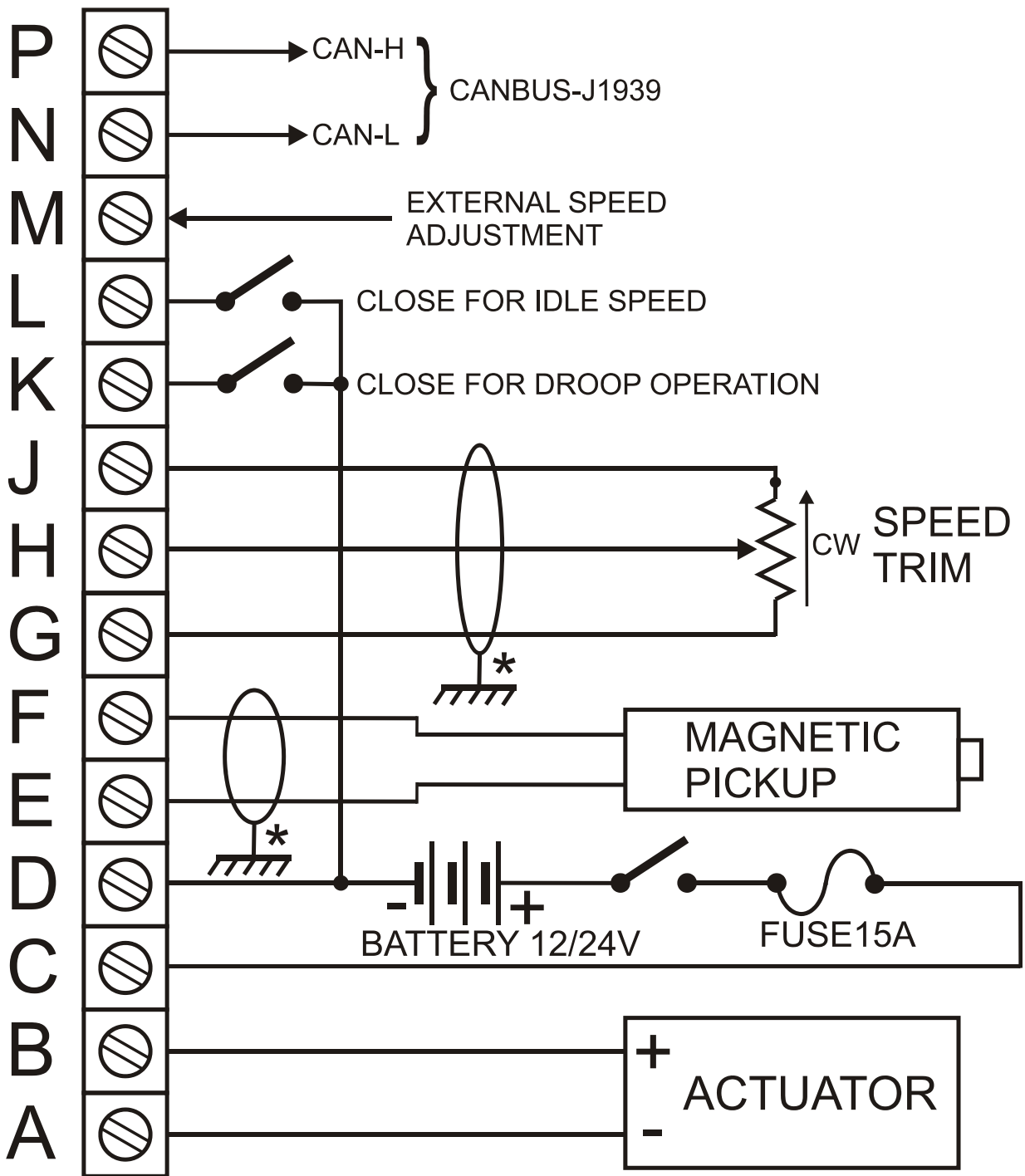

* GROUND AT ONE END ONLY

11. DECLARATION OF CONFORMITY

The unit conforms to the EU directives

-2014/35/EC (low voltage)

-2014/30/EC (electro-magnetic compatibility)

Norms of reference:

EN 61010 (safety requirements)

EN 61326 (EMC requirements)

The CE mark indicates that this product complies with the European requirements for safety, health environmental and customer protection.

12. MAINTENANCE



DO NOT OPEN THE UNIT !

There are NO serviceable parts inside the unit.

Wipe the unit, if necessary, with a soft damp cloth. Do not use chemical agents

13. DISPOSAL OF THE UNIT

Following **DIRECTIVE 2002/96/EC OF THE EUROPEAN PARLIAMENT AND OF THE COUNCIL of 27 January 2003 on waste electrical and electronic equipment (WEEE)**, this unit should be stored and disposed separately from the usual waste.

14. ROHS COMPLIANCE

The European ROHS directive restricts and prohibits the use of some chemical materials in electronic devices.

Following the “**DIRECTIVE 2011/65/EU OF THE EUROPEAN PARLIAMENT AND OF THE COUNCIL of 8 June 2011 on the restriction of the use of certain hazardous substances in electrical and electronic equipment**”, this product is listed in annex-I under category: “**Monitoring and control instruments including industrial monitoring and control instruments**” and exempted from ROHS directive.

However, Datakom is not using any ROHS non-compliant electronic components in the production. Only the solder contains lead. The switching to unleaded soldering is in progress.

15. TROUBLESHOOTING GUIDE



Below is a basic list of most often encountered troubles. More detailed investigation may be required in some cases.

The actuator is inoperative:

1) Measure the DC-supply voltage between terminals C(+) and D(-) of the unit. You should read the battery voltage, if not:

- a) Check for a blown fuse
- b) Check connections and wiring

2) With the unit powered-up, momentarily connect terminals B and C. The actuator should open completely. If not:

- a) Check a mechanical obstruction on the actuator lever manually.
- b) Measure the DC voltage on the actuator terminals:
 - If the battery voltage is present, then the actuator is damaged.
 - If there is no voltage, then check the actuator wiring.
- c) If the fuse blows, then check a short circuit in the wiring.

3) Crank the engine. Measure the AC voltage between terminals E and F. It should be at least 1VAC_RMS. If not:

- a) Check the gap between the speed sensor and the gear teeth. If needed then readjust it.
- b) Check wiring.
- c) The speed sensor may be defective.

4) Crank the engine. Measure the DC battery voltage while cranking. It should be above 8 VDC for a 12V system and 16V for a 24V system. If below:

- a) The battery is weak or discharged.

5) If the battery voltage is correct:

- a) Speed adjustment is set too low, readjust.
- b) The unit is defective.

The engine speed is too low:

1) Check the speed setting.

2) While engine running under governor control, measure the DC voltage between terminals A and B. If the voltage is close to the battery voltage:

- a) the actuator lever is mechanically obstructed from moving until full fuel position. Check mechanically that the lever has enough freedom of movement.
- b) The spring mechanical resistance is too strong for the actuator. Check with a softer spring.
- c) Check for misalignments and frictions on the actuator-fuel lever systems.

Engine overspeeds:

Do not crank again.

1) With the unit powered-up, if the actuator opens fully:

- a) Disconnect wiring at terminals E and F.

If the actuator closes then the speed signal is faulty, probably due to electrical noises. Check shielding and wiring.

If the actuator is still open, then disconnect the terminal B. If the actuator is still open, then the actuator is feeded by an external connection or short circuit. If the actuator shuts-off then the unit is damaged.

Speed unstable:**1) Readjust GAIN and STABILITY as described in chapter 8.****2) Check the speed sensor for:**

- a) Signal strength
b) Wiring
c) Shielding

3) Check the actuator-fuel lever system for loose mechanical linkage, or friction:

- a) Make the checks while the engine is operating.

4) Check for electromagnetic disturbance sources in close proximity as:

- a) battery chargers
b) ignition systems
c) radio transmitters.

Make a test by turning them off momentarily. If the stability cannot be reached, then enclose the unit in a separate and grounded metal sheet cabinet.

Systems in very harsh electromagnetic conditions as found in close proximity of powerful transmission systems may require shielding on all cables and even special EMI shielding.

5) Check the engine fuel and injection system:

Faulty injectors, blocked filters etc... may prevent the governor controller to maintain a constant speed.